

GENERAL FEATURES

This system makes it possible to repair or create shaped metal tubes with extreme ease and a secure seal.

A joint consisting of a sleeve and two sliding Lokring bushings, already assembled on the sleeve, is used.

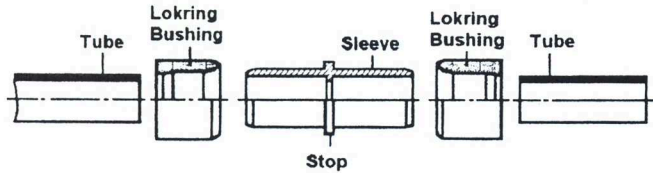

Fig. 1

The tubes which are to be joined are inserted into the joint which is applied using the special pliers which slide the bushings onto the sleeve up to the stop. The special conical geometry of the Lokring bushing means that the sleeve's diameter is reduced (approx. 2%).

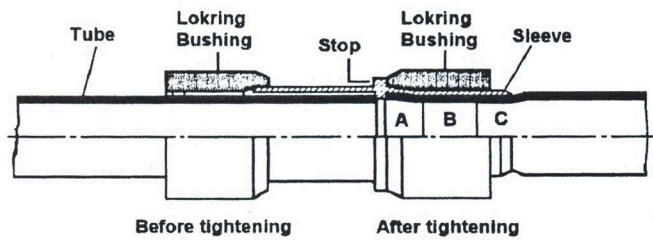

Fig. 2

The pressure of the sleeve on the tubes to be joined creates a radial forces balance between the sleeve and the tube, which guarantees the tightness of the joint.

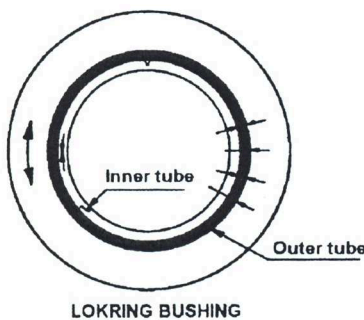

Fig. 3

APPLICATION

To avoid electrolytic reactions between the joint's various materials in certain humid conditions, the joint used must be of the right material, as shown in the following chart:

Material to be joined	Joint to be used
Aluminium - Aluminium	⇔ Aluminium Lokring
Aluminium - Copper	⇔ Aluminium Lokring
Aluminium - Steel	⇔ Aluminium Lokring
Steel - Steel	⇔ Brass Lokring
Steel - Copper	⇔ Brass Lokring
Copper - Copper	⇔ Brass Lokring

JOINT SPECIFICATIONS

Work pressure permitted: 50 bar

Maximum pressure permitted: 200 bar

The joint's bursting pressure is generally greater than the tube's.

It can be used within a temperature range of: $-50^{\circ}\text{C} > +150^{\circ}\text{C}$

The seal is guaranteed by the pressure exerted on the surface of the tubes.

OTHER FEATURES

No special treatment is required for the surfaces being joined.

No welding methods are used and so there is no danger from naked flames and released toxic gases.

The tubes being joined do not need to be disassembled if they are in a position where it is possible to work.

The job only takes a few minutes, thereby eliminating the problem of finding a replacement part.

It is possible to create shaped tubes for special applications.

The technology is patented and used throughout the world.

INSTRUCTIONS FOR USE

- 1) Make a sharp cut on each end of the tubes being joined using the tube cutter.

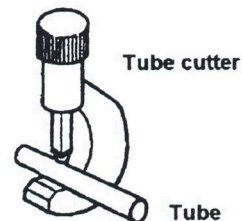

Fig. 4

- 2) Remove any paint and oil residues from the ends of the tubes using a very fine sandpaper.

NOTE: Sand with circular movements to avoid scratching the tubes lengthways.

- 3) Check the external diameter of the tubes being joined and choose the correct joint for the job. The size is

indicated on the joint.

- Assemble on the pliers the right size pair of jaws for the tubes being united according to the following chart:

041379.5	(8) for tubes up to \varnothing 8 mm
041379.6	(10) for tubes from \varnothing 9 to 11 mm
041379.7	(12) for tubes from \varnothing 12 to 13 mm
041379.8	(16) for tubes from \varnothing 14 to 16 mm

To assemble the jaws: remove the relative pin, position the jaw and then replace the pin in its seat (using pressure).

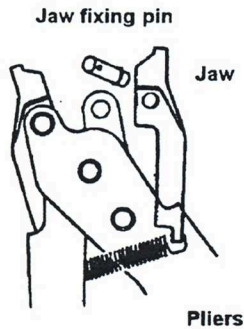

Fig. 5

- Apply a thin layer of the special sealant on the ends of the tubes. Insert the tubes into the joint up to the stop and **rotate the joint to spread the sealant evenly**.

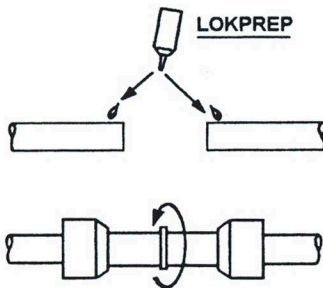

Fig. 6

NOTE: The sealant is necessary in order to avoid any eventual lengthwise scratching of the tube, caused by the work, compromising the joint's seal.



Fig. 7

- Open the pliers completely and reclose the handle with the articulated joint until the pliers are blocked in the open position (A).

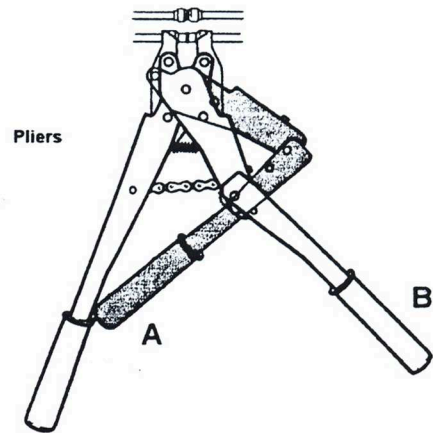

Fig. 8

- Position the joint correctly between the jaws of the pliers and jack the articulated arm until the two Lokring bushings are at the stop, taking care not to let the tubes being joined slip out of the joint.
N.B.: As soon as the bushings reach the stop, interrupt the pliers action to avoid stresses which could damage the tube.

FOR SINGLE STOP JOINTS

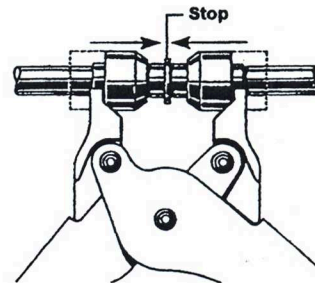

Fig. 9

FOR DOUBLE STOP JOINTS

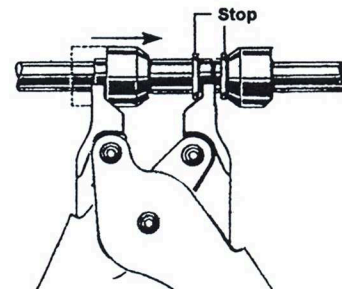
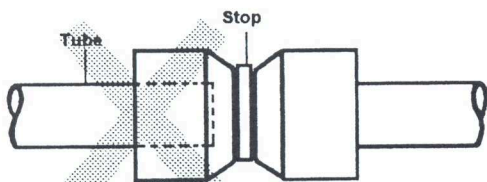
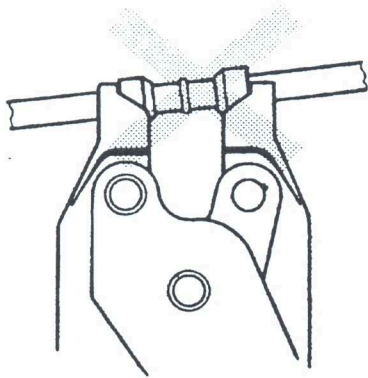

Fig. 10

- Wait a few minutes before moving the tubes then proceed as normal.



INCORRECT



Tube not fully inserted on the stop

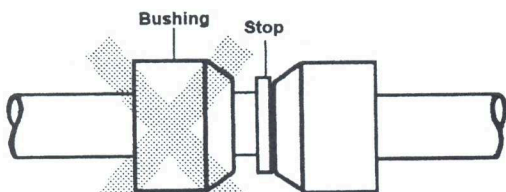

Bushing not fully inserted on the stop

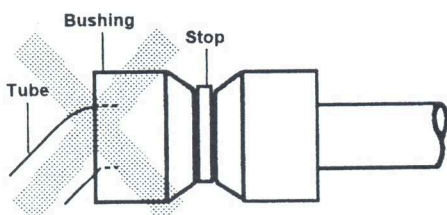

Bushing inserted on the curved part of the tube

CORRECT

