



Diavia

FIAT DUCATO 2.2 MJT
(Serie X250) "101 HP" EURO4

FORD TRANSIT 2.2 TDCi
(DURATORQ "110HP") EURO4

CITROEN JUMPER 2.2 HDi
"101 -120 HP" EURO4

PEUGEOT BOXER 2.2 HDi
"101 -120 HP" EURO4

Montaggio compressore

Pose compresseur

Compressor installation

Einbau des Kompressors

Montaje compresor

Codice/Code: 7FI269 (A07FI269)

Istruzioni di montaggio

Instructions pour le montage

Fitting instructions

Einbauanleitungen

Instrucciones de montaje

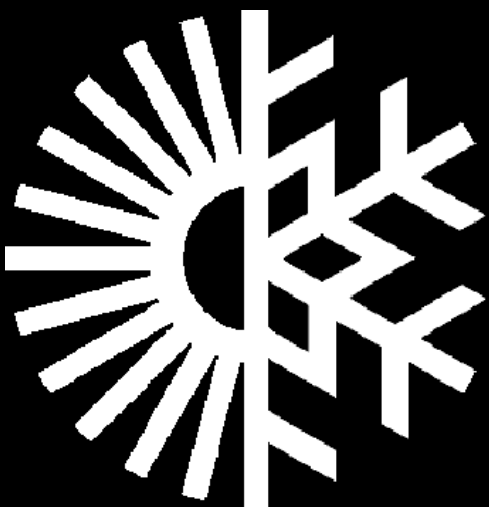

DELPHI ITALIA AUTOMOTIVE SYSTEMS S.r.l. "Stabilimento Molinella"

Via Nobili, 2 40062 Molinella (Bologna) - Italy

Telefono (0039) 051.6906111 - Fax (0039) 051.6906287 - Email: diavia.service@delphi.com

**DESCRIZIONE SIMBOLOGIA UTILIZZATA / DESCRIPTION DE LA SYMBOLOGIE UTILISÉE
DESCRIPTION OF SYMBOLS USED / BESCHREIBUNG DER VERWENDETEN SYMBOLIK
DESCRIPCIÓN DE LOS SIMBOLOS UTILIZADOS**

1A Riferimento a figura / Référence à la figure / See figure
In Bezug auf Abbildungen / Referencia a la figura

1 Riferimento a componenti di fornitura / Référence aux composants de la fourniture
See supplied components / Bezug auf Gelieferte Einbauelemente
Referencia a los componentes de abastecimiento

1 Riferimento a posizione schema elettrico / Référence à la position du schéma électrique
See position in wiring diagram / In Bezug auf Position im Schaltschema /
Referencia a la posición del esquema eléctrico



- Lubrificare tutti i raccordi e gli O.R. con il nuovo olio refrigerante prima di collegarli
- Graisser tous les raccords et les O.R. avec le nouveau huile réfrigérant avant de les raccorder

-Lubricate all fittings and O-rings with new refrigerant oil before connecting them

- Alle Verbindungsstücke und OR-Ringe vor deren Verbindung mit dem neuen Kühlmittellöl ölen

- Lubrificar todos los empalmes y los O.R. con el nuevo aceite refrigerante antes de conectarlos

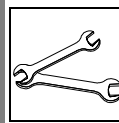

- Per avvitare a fondo o allentare i raccordi tubi gas usare due chiavi per bilanciare coppia di torsione

- Pour visser à fond ou desserrer les raccords des tuyaux gaz, utiliser le deux clés pour équilibrer le couple de torsion

- When tightening or loosening the fittings of the gas pipes, use two wrenches to equalize the torsion couple

- Um die Verbindungsstücke der Kältemittelschläuche gleichmäßig festzuschrauben oder zu lockern, zwei Schlüssel für das Verschraubungspaar verwenden

- Para enroscar a fondo o aflojar los empalmes tubos gas se deben usar dos llaves para balancear el par de torsión



- Tagliare con utensile appropriato al materiale
- Couper à l'aide d'outil approprié
- Cut with a device suitable for the material



- Mit dem Material entsprechendem Werkzeug schneiden
- Cortar con herramienta apropiada al material

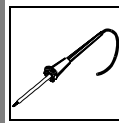

- Stagnare
- Étamer
- Tin
- Verzinnen
- Estañar



- Spianare
- Nivelar
- Flatten out
- Richten
- Nivelar

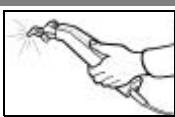

- Tagliare con utensile a lama calda
- Couper à l'aide d'un outil à lame chaude
- Cut using the tool with heated blade.
- Mit Schweißmesserwerkzeug schneiden
- Cortar con útil a hoja caliente

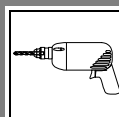

- Forare
- Percer
- To drill
- Durchbohren
- Taladrar

Pos.	ITALIANO	FRANÇAIS	ENGLISH	DEUTSCH	ESPAÑOL
1	Piastra supporto compressore	Plaque support compresseur	Compressor support plate	Kompressorträger	Placa soporte compresor
2	Staffa isolata di supporto puleggia galoppino tendicinghia	Bride de support rainurée poulie galet tendeur de courroie	Slotted belt tightening idle pulley support bracket	Verstellhalter der Spannriemenscheibe	Abrazadera ojalada de soporte polea directriz tensor de correa
3 - 7 - 9	Distanziale	Entretoise	Shim	Absandsstück	Distanziador
4 - 8	Puleggia galoppino	Poulie de renvoi	Idle pulley	Leitrollenriemenscheibe	Polea directriz
5	Perno	Pivot	Pin	Bolzen	Perno
6	Compressore	Compresseur	Compressor	Kompressor	Compresor
6.1	Cablaggio PACKARD per compressore	Câblage PACKARD pour compresseur	PACKARD wiring for compressor	PACKARD Kabelstrang für Kompressor	Cableado PACKARD para compresor
10	Cinghia	Courroie	Belt	Riemen	Correa
11	Bulloneria	Boulonnerie	Nuts and bolts	Schraubensatz	Tornillería

**MONTAGGIO COMPRESSORE / POSE DU COMPRESSEUR / COMPRESSOR FITTING
KOMPRESSOREINBAU / MONTAJE COMPRESOR**

MATERIALE FORNITO / MATERIEL FOURNI / SUPPLIED MATERIAL / GELIEFERTES MATERIAL / MATERIAL ABASTECIDO

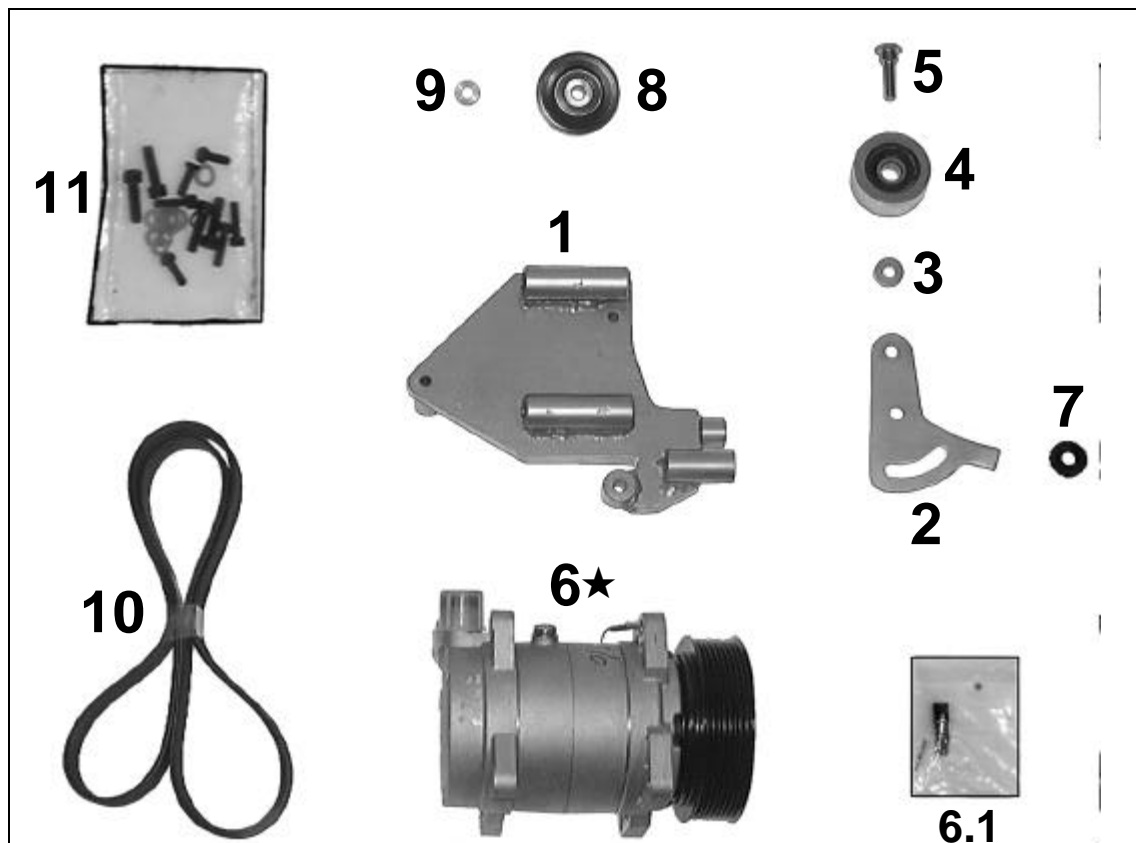

7FI269 (A07FI269)

1A

Componente d'acquisto a cura dell'installatore, non inserito nel KIT A07FI269

Composant à acheter par l'installateur, non fourni dans le Kit A07FI269

★ *Component to be purchased by the installer. Not included in KIT A07FI269*

Nicht im Einbausatz A07FI269 enthaltene und vom Einbauer separat zu kaufende Einbauteile
Componente de compra a cargo del instalador, no incluido en el Kit A07FI269

Pos.	Descrizione / Description / Description / Beschreibung / Descripción	Codice / Code Code / Código
1	Piastra supporto compressore	0011248/0
2	Staffa asolata di supporto puleggia galoppino tendicinghia	0021803/1
3	Distanziale $\phi 10,5 \times \phi 22 \times 7$	009041ZN
4	Puleggia galoppino	004072/0
5	Perno	005034/0
6★	Compressore	015203/1
6.1	Cablaggio PACKARD per compressore	0282113/1
7	Distanziale $\phi 10 \times \phi 27 \times 3$	009079/1
8	Puleggia galoppino	004084/0
9	Distanziale $\phi 10 \times \phi 20 \times 6$	009049ZN
10	Cinghia 6K x 1420	013705/0
11	Bulloneria	037FI269

**FORI DI FISSAGGIO / TROUS DE FIXATION / SECURING HOLES
BEFESTIGUNGSBOHRUNGEN ORIFICIOS DE FIJACIÓN**

FIAT DUCATO / CITROEN JUMPER / PEUGEOT BOXER

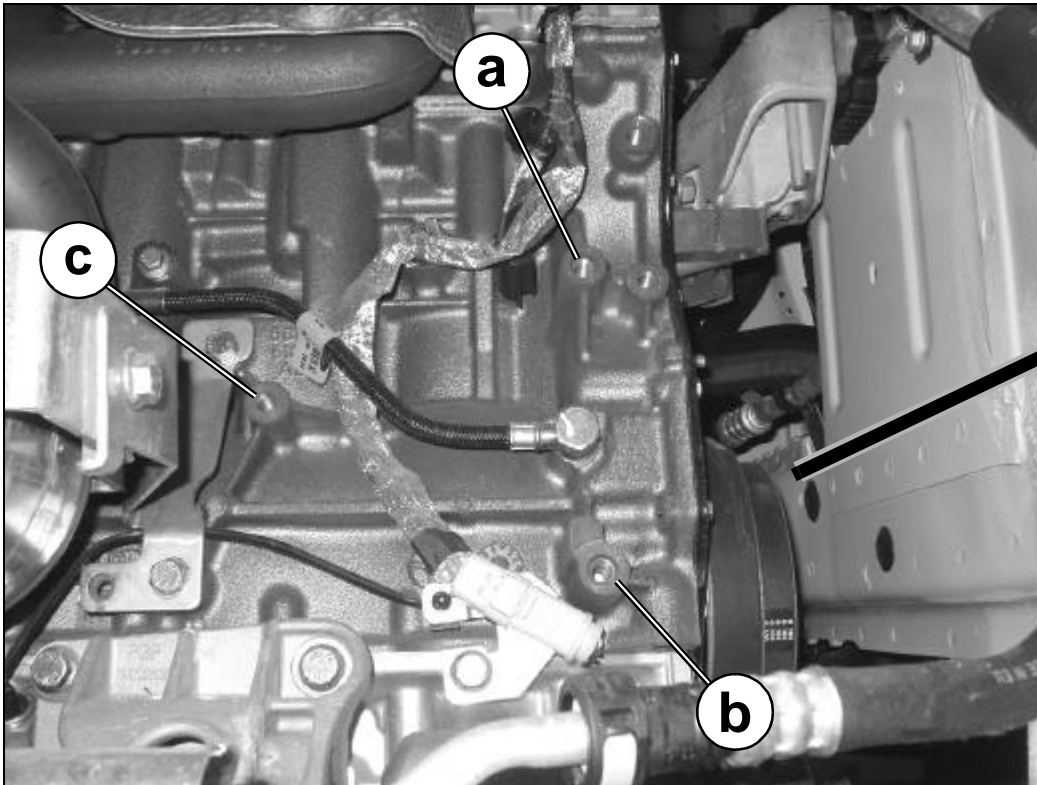

ELIMINARE
ELIMINER
DISCARD
ENTFERNEN
ELIMINAR
**ORIGINALE
ORIGINAL**

2A

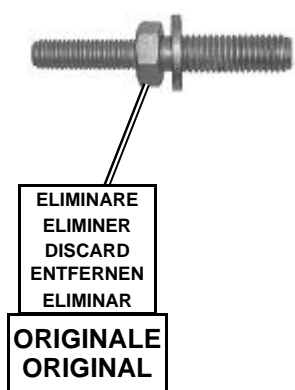
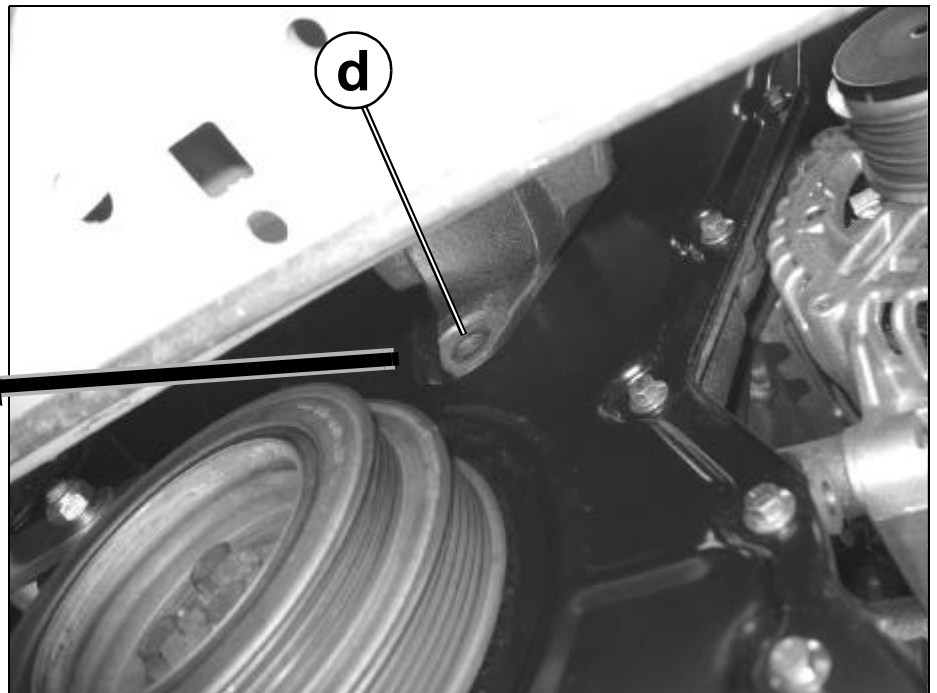

ELIMINARE
ELIMINER
DISCARD
ENTFERNEN
ELIMINAR
**ORIGINALE
ORIGINAL**

**FORI DI FISSAGGIO / TROUS DE FIXATION / SECURING HOLES
BEFESTIGUNGSBOHRUNGEN ORIFICIOS DE FIJACIÓN**

FORD TRANSIT

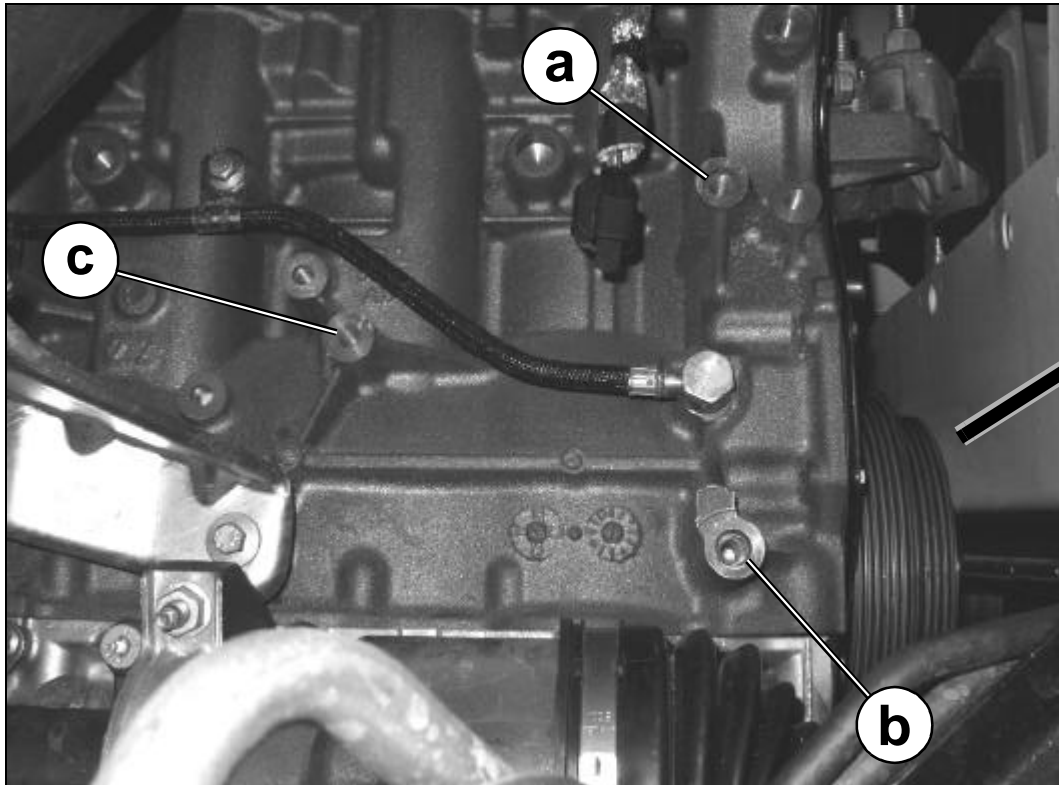

2.1A

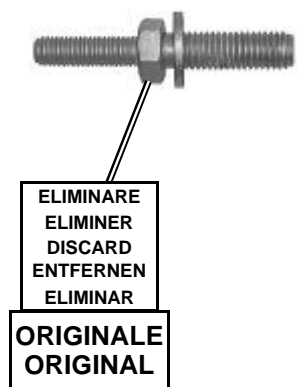
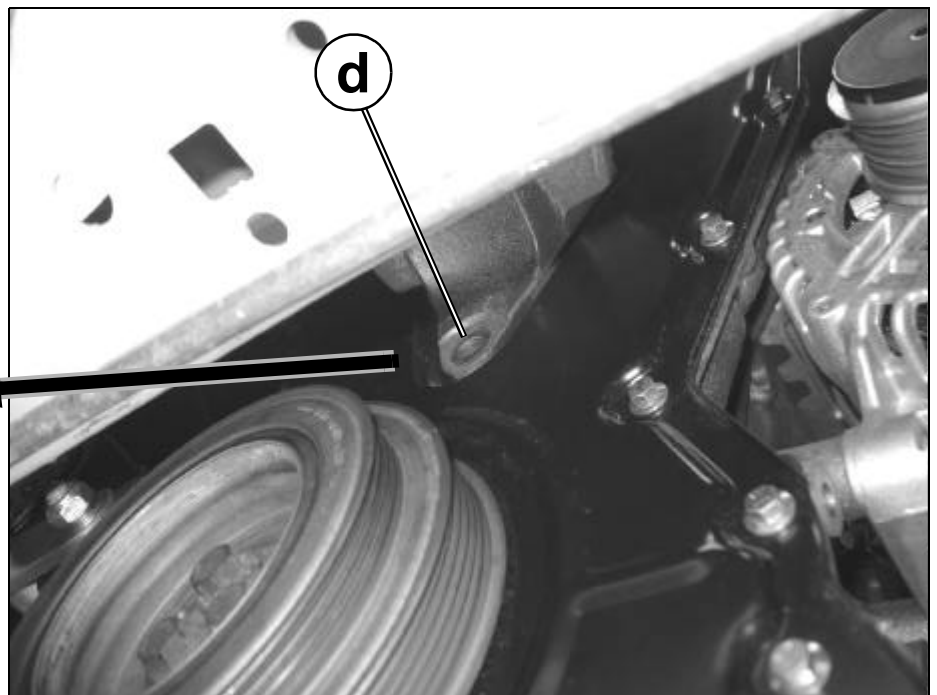

SBLOCCARE
DÉBLOQUER
RELEASE
LOCKERN
DESBLOQUEAR

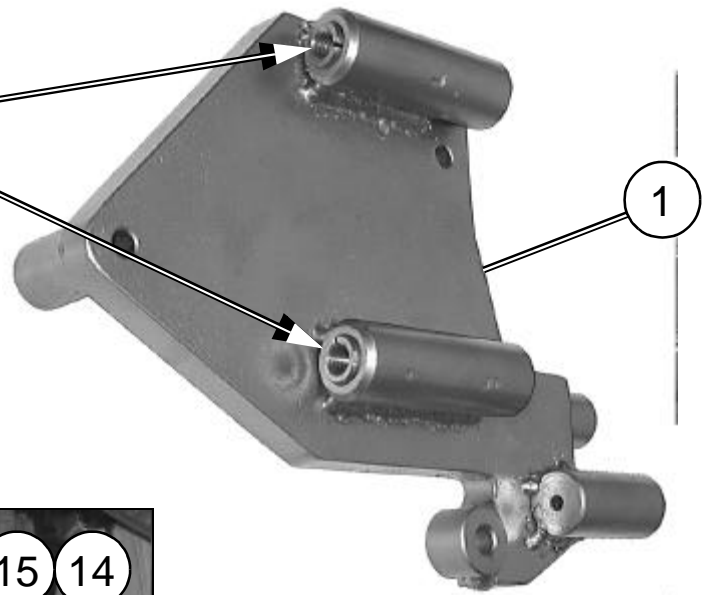

**FIAT DUCATO
CITROEN JUMPER
PEUGEOT BOXER**

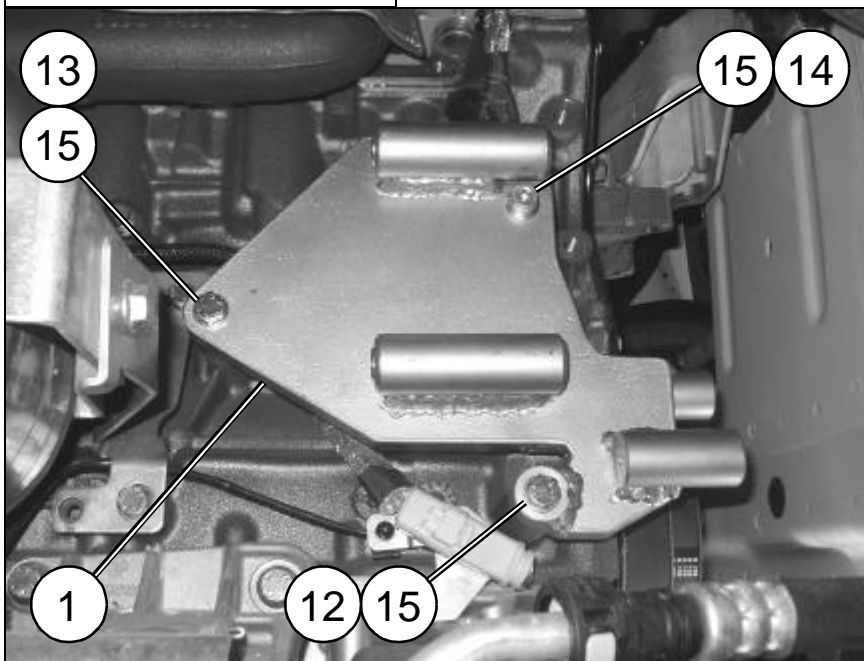

3A

**BULLONERIA DA UTILIZZARE
BOULONNERIE A UTILISER
NUTS AND BOLTS TO BE USED
ZU BENUTZENDER SCHRAUBENSATZ
TORNILLERIA A UTILIZAR**

Pos.	Tipologia Typologie Typology Tipologie Tipologia	Descrizione Description Description Beschreibung Descripción
12		M8x40
13		M8x65
14		M8x50
15		φ 8

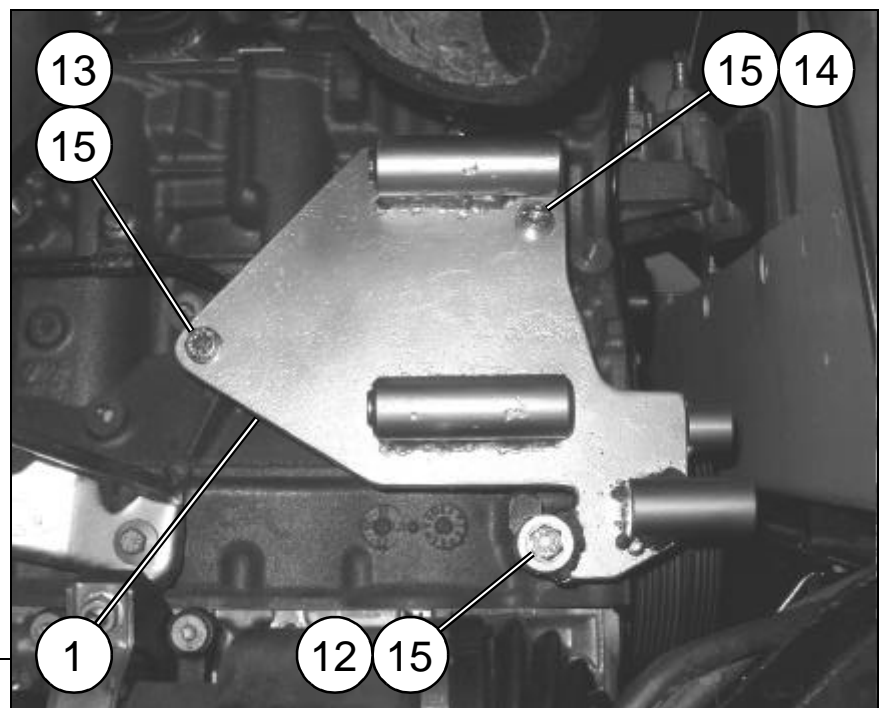

FORD TRANSIT

(I)

ATTENZIONE: Qualora si decida per il funzionamento dell'impianto di refrigerazione con utilizzo di fluido refrigerante "R404a" (funzionamento di refrigerazione con temperature negative), prima di installare il compressore è necessario svuotare tutto l'olio in esso contenuto e sostituirlo con olio appropriato fornito.

(F)

ATTENTION: Dans le cas où l'on décide pour le fonctionnement de l'installation de réfrigération l'utilisation du fluide réfrigérant "R404a" (fonctionnement de réfrigération avec des températures négatives), avant d'installer le compresseur il faut le vider de toute l'huile qu'il contient et la remplacer par de l'huile appropriée fournie.

(GB)

WARNING: If the refrigeration system is to be operated using "R404a" refrigerant fluid (refrigeration operating with negative temperature), before installing the compressor, empty out all oil contained in the compressor and replace it with the appropriate oil supplied.

(D)

ACHTUNG: Sollte für die Inbetriebnahme der Kühlungsanlage Kühlmittel "R404a" verwendet werden (Kühlungsfunktion mit Minus-Temperaturen) vor dem Einbau des Kompressors das darin befindliche Öl vollständig entleeren und dieses mit dem dafür geeigneten gelieferten Öl ersetzen.

(E)

ATENCIÓN: Si se decide por el funcionamiento de la instalación de refrigeración y utilizar fluido refrigerante "R404a" (funcionamiento de refrigeración con temperaturas negativas), antes de instalar el compresor es necesario vaciar todo el aceite que tiene dentro y sustituirlo con el aceite apropiado que se entrega.

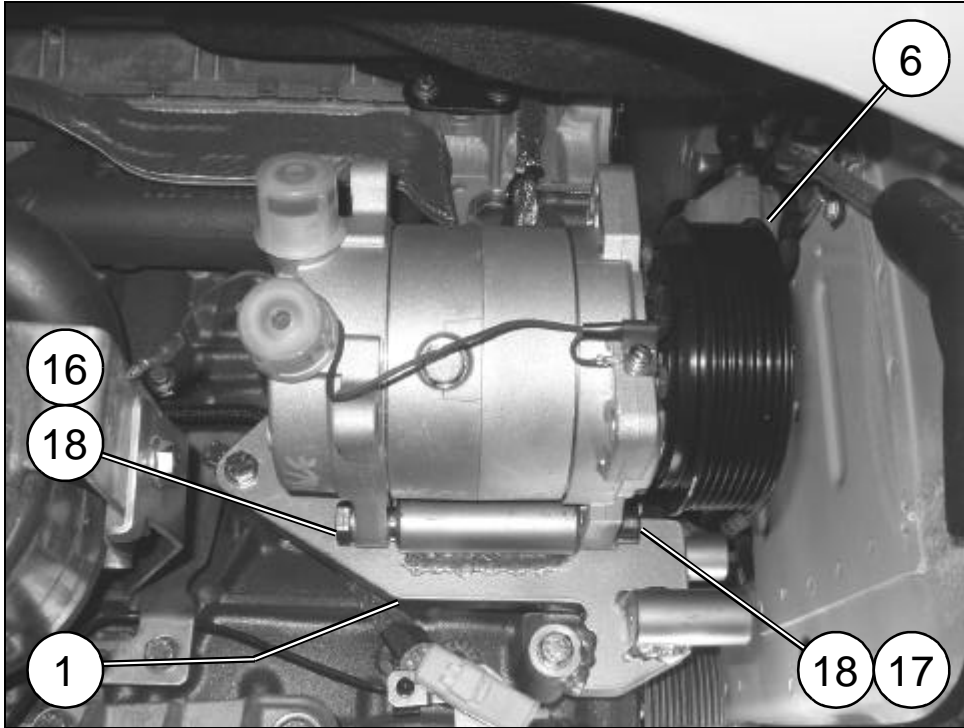

**FIAT DUCATO
CITROEN JUMPER
PEUGEOT BOXER**

4A

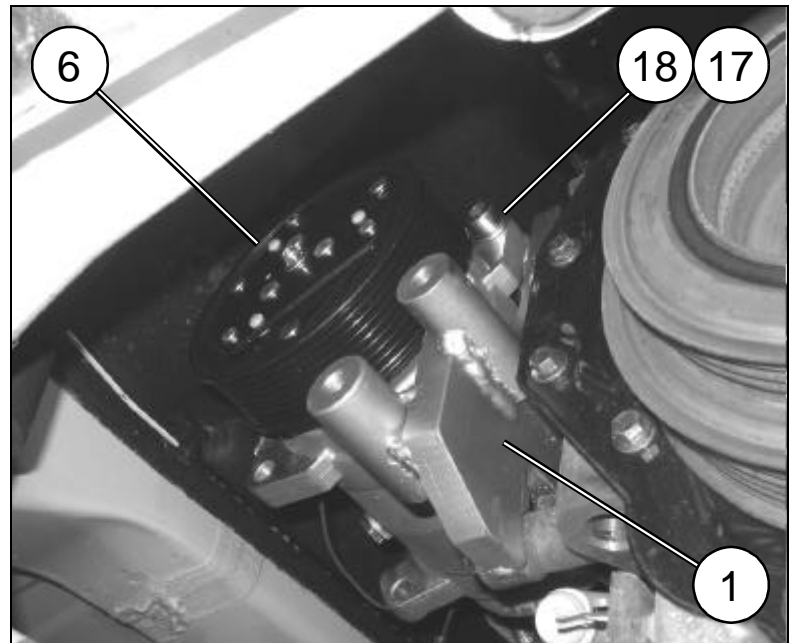
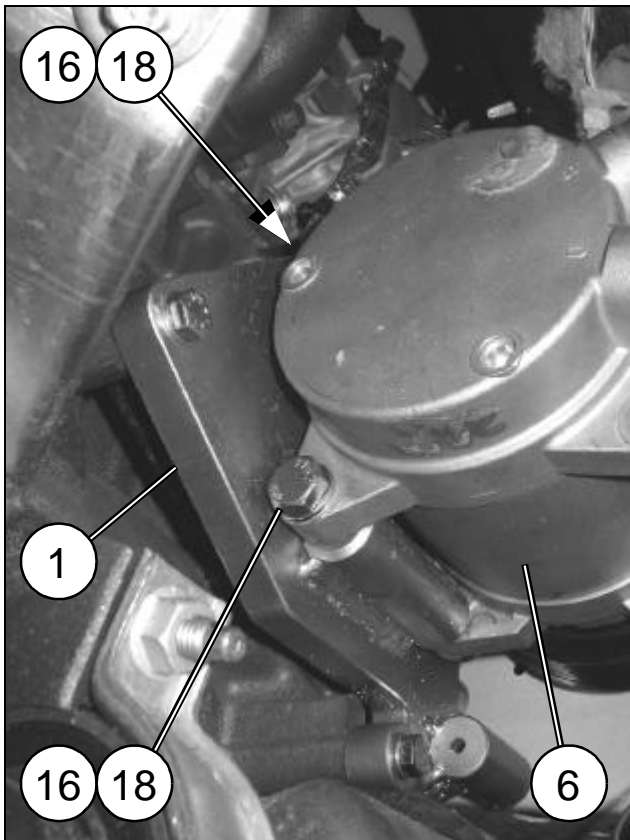

BULLONERIA DA UTILIZZARE / BOULONNERIE A UTILISER NUTS AND BOLTS TO BE USED / ZU BENUTZENDER SCHRAUBENSATZ TORNILLERIA A UTILIZAR		
Pos.	Tipologia / Typologie Typology / Tipologie Tipologia	Descrizione / Description Description / Beschreibung Descripción
16		M10x30
17		M10x30
18		φ 10



FORD TRANSIT

5A

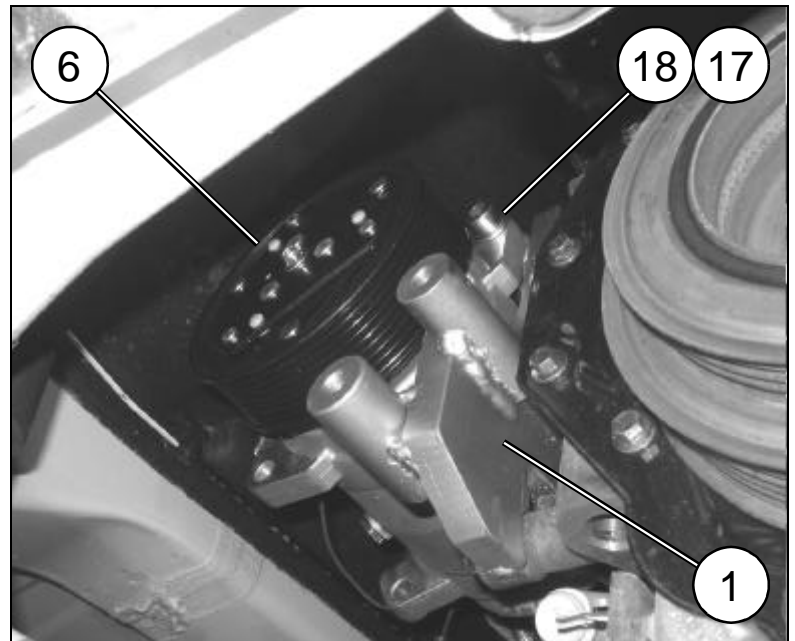
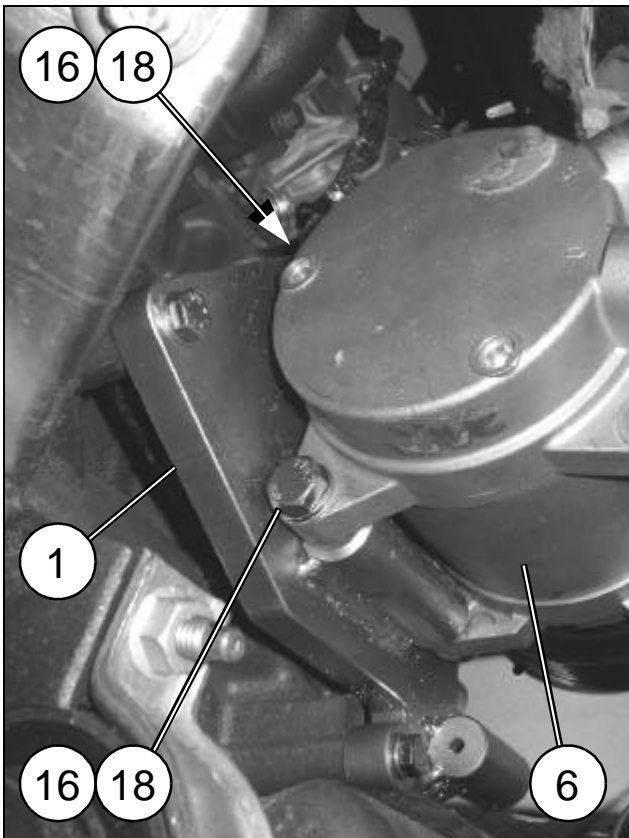

BULLONERIA DA UTILIZZARE
BOULONNERIE A UTILISER
NUTS AND BOLTS TO BE USED
ZU BENUTZENDER SCHRAUBENSATZ
TORNILLERIA A UTILIZAR

Pos.	Tipologia / Typologie Typology / Tipologie Tipologia	Descrizione / Description Description / Beschreibung Descripción
16		M10x30
17		M10x30
18		φ 10

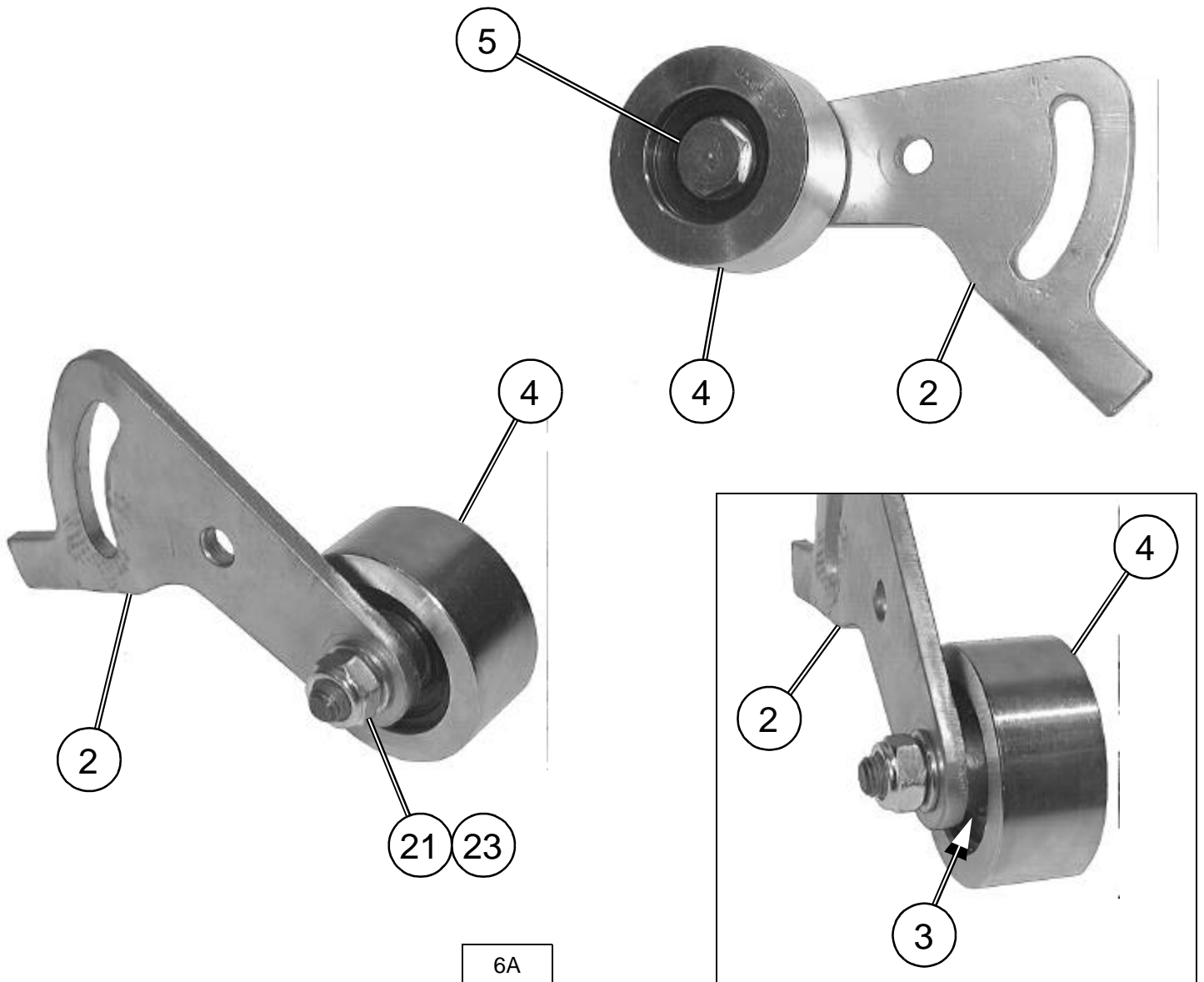

6A

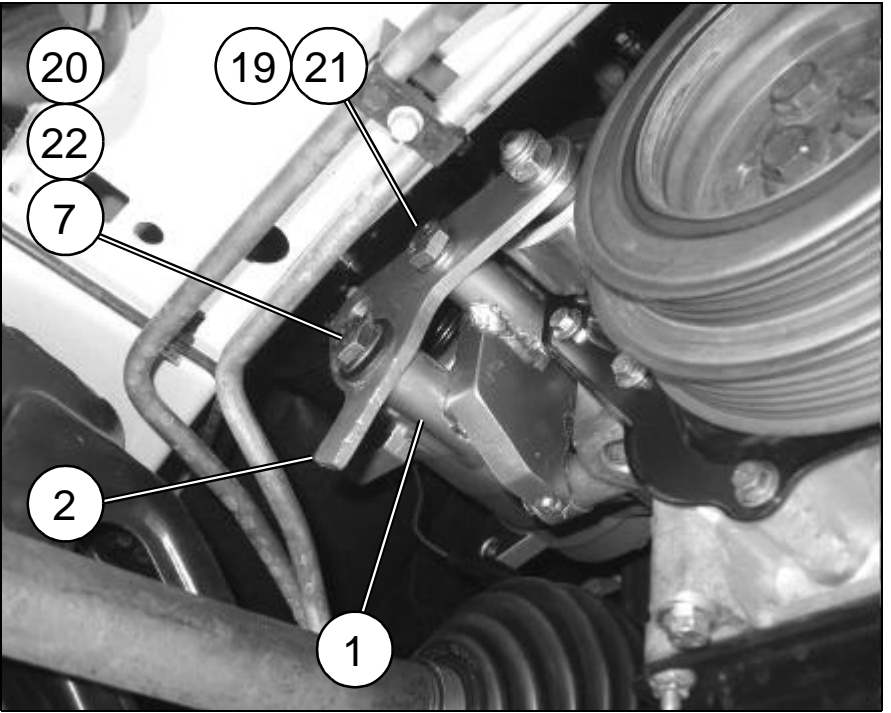

BULLONERIA DA UTILIZZARE BOULONNERIE A UTILISER NUTS AND BOLTS TO BE USED ZU BENUTZENDER SCHRAUBENSATZ TORNILLERIA A UTILIZAR		
Pos.	Tipologia Typologie Typology Tipologie Tipologia	Descrizione Description Description Beschreibung Descripción
19		M10x25
20		M10x30
21		φ 10
22		φ 10
23		M10

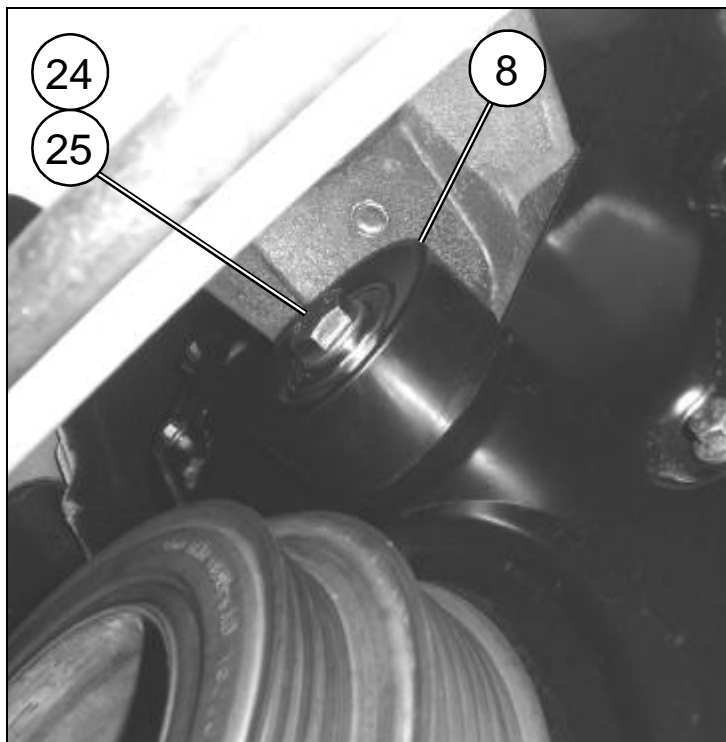

7A

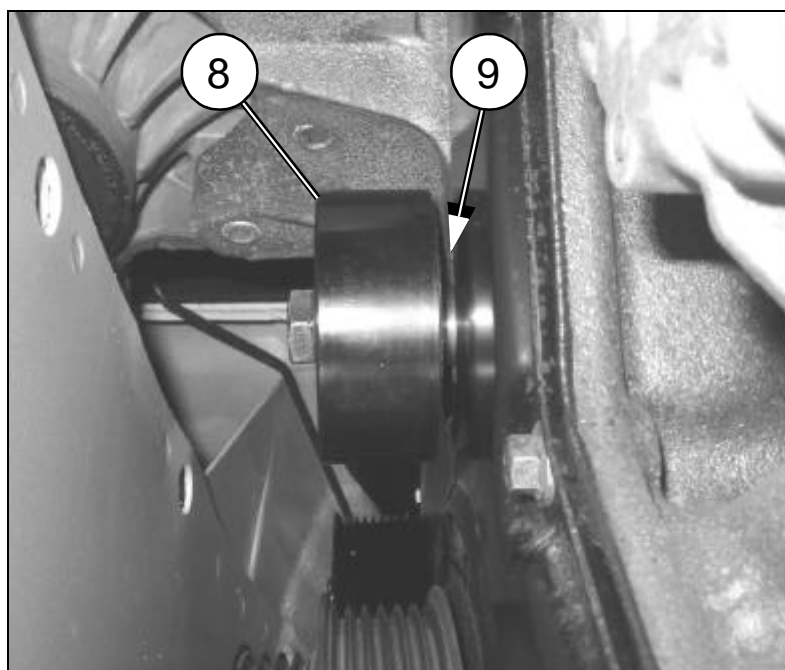

BULLONERIA DA UTILIZZARE BOULONNERIE A UTILISER NUTS AND BOLTS TO BE USED ZU BENUTZENDER SCHRAUBENSATZ TORNILLERIA A UTILIZAR		
Pos.	Tipologia Typologie Typology Tipologie Tipologia	Descrizione Description Description Beschreibung Descripción
24		M10x60
25		φ 10



8A

ORIGINELE
ORIGINAL

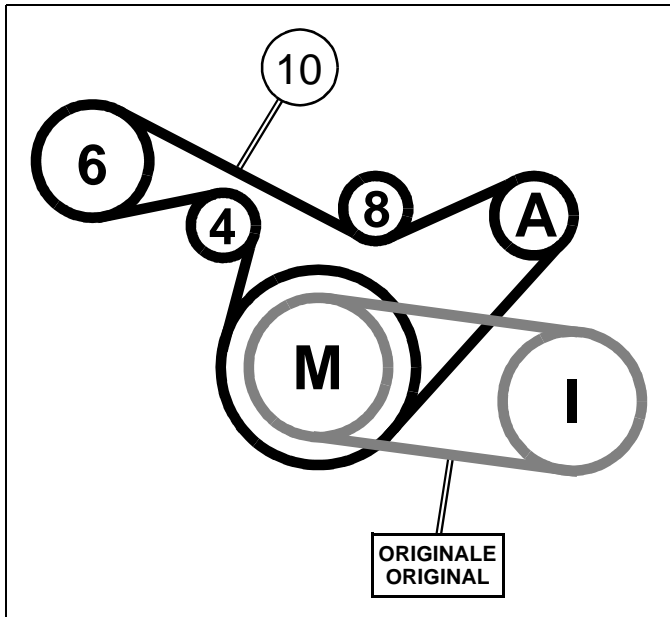

ORIGINELE
ORIGINAL

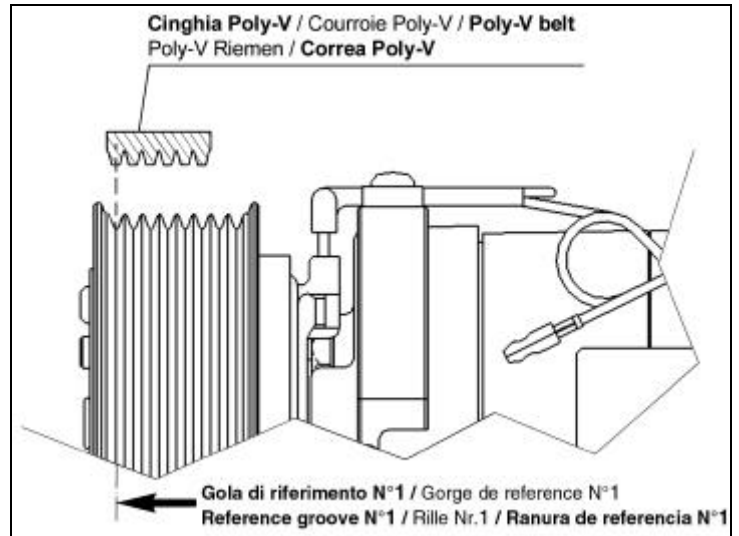

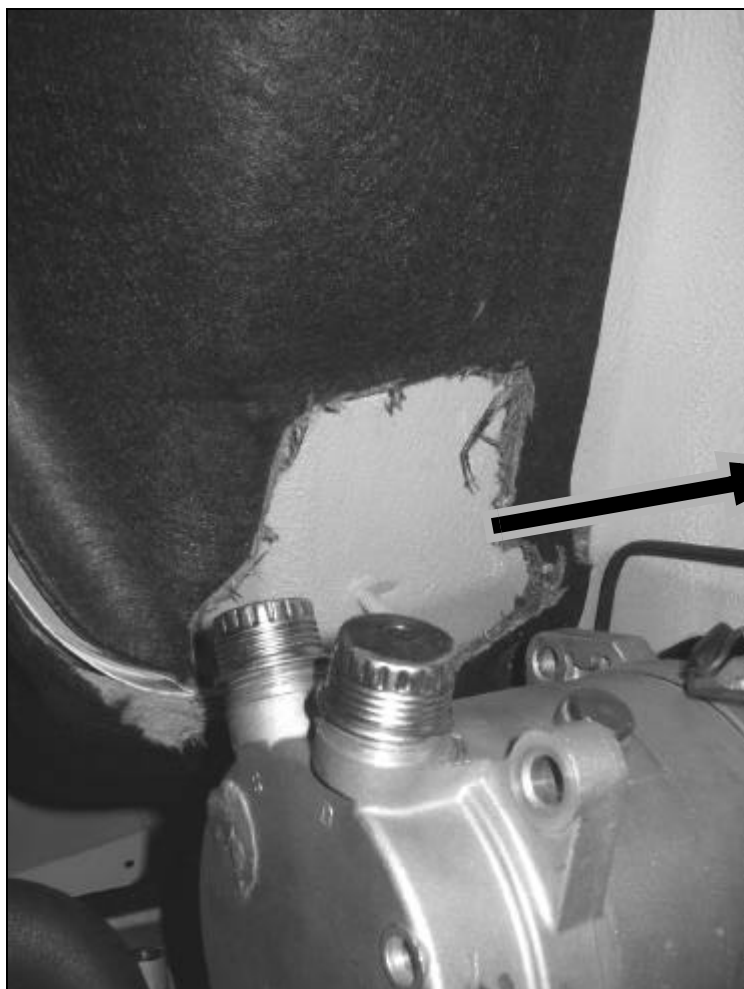

FORD TRANSIT



**ASPORTARE IMBOTTITURA
ENLEVER LE REMBOURRAGE
REMOVE PADDING
POLSTERUNG ENTFERNEN
QUITAR EL MULLIDO**

9A

(I)
DELPHI ITALIA mira ad un costante miglioramento dei propri prodotti. La Casa si riserva il diritto di apportare in qualunque momento e senza preavviso modifiche ai modelli e ai componenti descritti in questa pubblicazione per ragioni di natura tecnica o commerciale. Per ulteriori informazioni rivolgersi al servizio assistenza DELPHI.

(F)
DELPHI ITALIA vise à une amélioration constante des ces produits. La maison se réserve le droit d'apporter, à tout moment et sans préavis, des modifications aux modèles et aux composants décrits dans cette publication pour des raisons d'ordre technique ou commerciale. Pour d'ultérieures informations s'adresser au service d'assistance DELPHI.

(GB)
DELPHI ITALIA focuses on constant upgrading of its products. The Manufacturer reserves the right to modify the models and components described in the present publication at any time for technical or commercial reasons and without prior notice. For further information, contact DELPHI technical services.

(D)
DELPHI ITALIA ist stets bestrebt die eigenen Produkte zu verbessern. Die Herstellerfirma behält sich das Recht vor, aus technischen oder Verkaufsgründen, zu jeder Zeit und ohne vorherige Ankündigung, Abänderungen an den Modellen und den in dieser Veröffentlichung beschriebenen Einbauteile vorzunehmen. Für weitere Informationen bitten wir Sie, sich an unseren DELPHI Kundendienst zu wenden.

(E)
DELPHI ITALIA aspira a un constante mejoramiento de su producción. La Fábrica se reserva el derecho de aportar en cualquier momento y sin preaviso modificaciones a los modelos y los componentes descritos en esta publicación por razones técnicas o comerciales. Para ultiores informaciones dirigirse al servicio asistencia DELPHI.

VENDITA E SERVIZIO
VENTE ET SERVICE

VERKAUF UND SERVICE
SALE AND SERVICE

DELPHI ITALIA AUTOMOTIVE SYSTEMS S.r.l.
Stabilimento Molinella

Via Nobili, 2 40062 Molinella (Bologna)-Italy
Telefono (0039) 051.6906111

Fax (0039) 051.6906287

Email: diavia.service@delphi.com

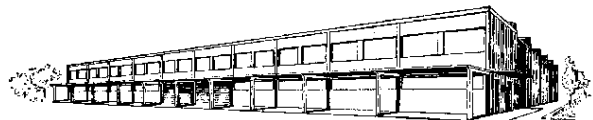

MOD. SCHFI369

II / '08
(2006)

Questa pubblicazione è stata curata da DELPHI ITALIA-Diavia
Ufficio Fitting Instructions - Stabilimento Molinella

This publication has been edited by DELPHI ITALIA-Diavia
Fitting Instructions Office - Factory Molinella